



High-Reliability DC Power Supplies PAN-A Series

0 V to 600 V DC, 0 A to 50 A, 28 models

Low noise and highly stable output achieved using the series regulation system

Basic DC power supplies, superior for general-purpose use.

PAN-A series

Basic DC Power Supplies Superior for General Purpose use...

Low temperature drift

Carefully selected components, improved circuit design, and heat dissipation based on the forced air cooling design have achieved a low-temperature drift of 100 ppm/°C (constant voltage characteristic) and 300 ppm/°C (constant current characteristic).

Quick transient response

Since the Error Amplifier has a characteristics of wide frequency bandwidth, stable gain, less phase shift and high loop gain, the PAN-A series is equipped with a highly stable and low output impedance as well as quick response to sudden change of the load. (Typical response time is 50 μ s)

Application

Incorporates a wide range of functions capable of systematization, including analog signal- or computer- (GPIB) based remote control, remote sensing, and master-slave-control serial and parallel operations.

(The PAN350-3.5A and PAN600-2A cannot be operated in series.)

The PAN-A series is a high-performance, highly reliable DC power supply unit featuring regulated variable voltage. These units are suitable for use in a range of fields including research and development, quality control, and production. The PAN-A series consists of a pre-regulator using FETs and a series regulator using power transistors, providing the high-quality input characteristic of the latter as well as the low power-source harmonic distortion of choke input type phase control.

To achieve the high reliability and safety important for power supply, components of sufficient derating and long-proven mounting techniques are used throughout. All models are carefully designed and furnished with over voltage protection (OVP) and various safety functions.

Line-up

	175 W type	350 W type	700 W type	1000 W type
16 V	PAN 16-10A	PAN 16-18A	PAN 16-30A	PAN 16-50A
35 V	PAN 35-5A	PAN 35-10A	PAN 35-20A	PAN 35-30A
60 V	PAN 60-3A	PAN 60-6A	PAN 60-10A	PAN 60-20A
70 V	PAN 70-2.5A	PAN 70-5A	PAN 70-8A	PAN 70-15A
110 V	PAN 110-1.5A	PAN 110-3A	PAN 110-5A	PAN 110-10A
160 V	PAN 160-1A	PAN 160-2A	PAN 160-3.5A	PAN 160-7A
250 V			PAN 250-2.5A	PAN 250-4.5A
350 V				PAN 350-3.5A
600 V				PAN 600-2A



Description on the Panel

Front Panel

Voltmeter, amperemeter

High-intensity LEDs offering good visibility are used. These meters indicate output voltage and current as well as output limit values.

Alarm display

“ALM” lights up when the OVP circuit is activated.

Limit switch

If this limit switch is held down, the voltmeter indicates the voltage limit value, and the amperemeter indicates the current limit value.

Output ON/OFF switch

ON/OFF can also be controlled with external signals.

Preset OVP switch

If this switch is held down, the voltmeter indicates the preset OVP value.

Power switch

The 175 W and 350 W models are designed so that the rectification circuit is shut down if the OVP function is activated. The 700 W and 1000W models, which use a circuit protector (NFB), are designed so that the power switch is automatically shut down if the OVP function is activated.

OVP variable resistor

This is used to preset the actuating point for OVP.

Sub-panel cover

A remote-control preset switch and variable resistors for various calibrations (with offset and full-scale adjustments) are located beneath the cover.



Voltage and current preset variable resistors

Shock-resisting 10-turn helical potentiometers are used (theoretical resolution: 0.018 %; a guard cap is used to change to a fixed or semi-fixed knob). These variable resistors are of a wire-wound design, and sliding surfaces are treated to prevent oxidation.

Front-side output terminals

Note: There is no auxiliary output terminal on the front panel of Model PAN16-50A.



Rear Panel

Control terminals

These terminals are used for remote control, parallel, or series operations. Note: The arrangement of sensing terminals for the PAN350-3.5A and PAN600-2A differ from other models: Terminal 1 is unassigned.

Fuse holder

(175 W and 1000 W type have this holder inside of the unit.)

Sensing terminals

These terminals are used for remote sensing.



AC input terminals

(175 W and 350 W type have AC receptacle instead.)

- Output terminals**
- Chassis ground terminal**
- Forced air-cooling exhaust port**

Application

The PAN-A series enables remote control of output voltage and current using analog signals. External contact points can also be used to control ON/OFF operations

Remote-control using external voltage

Item to be controlled	Control voltage*	Input impedance
Output voltage	0 to approx. 10V	Approx. 10 kΩ
Output current	0 to approx. 10V	Approx. 25 kΩ

* The control voltage circuit should be floated (insulated), since "common" is connected to the positive voltage side.

Remote-control using external resistor

Item to be controlled	Control resistor*	Current in resistor
Output voltage	Approx. 10 kΩ	Approx. 1 mA
Output current	Approx. 10 kΩ	Approx. 0.4 mA

* For the control resistors, use metal film or wire wound resistors of 1/2 W or larger capacity, a low temperature coefficient, and good aging stability.

Master-slave control of parallel operation

(This control is possible only for parallel-connected units of the same model.)

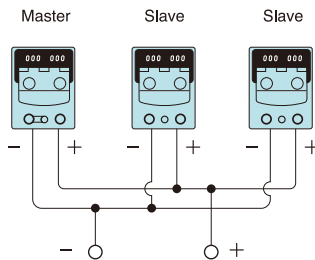

- The current capacity can be increased by connecting a multiple number of units of the same model in parallel. Output control can be performed by a master unit.
- Use only one master unit to perform remote sensing, remote control, and output on/off control.

* For one master unit, a maximum of two slave units can be connected in parallel.

Master-slave control of series operation

(This control is possible only for series-connected units of the same model.)

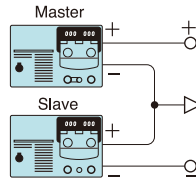

- The output voltage can be increased by connecting a multiple number of units of the same model in series. The unit on the top (i.e., the positive side) plays the role of master, and can control the output of the slave unit(s).
- The example shown above is a dual tracking power supply that can vary positive and negative voltages simultaneously.

* The number of slave units to be connected in series is determined by the rated output voltage and isolation voltage of each unit. Taking the PAN35-10A as an example for series connection: Since the rated output voltage is 35 V, and the isolation voltage is ± 250 V, $250/35 = 7.1$, i.e., up to 7 units including the master unit can be connected in series.

Note: PAN350-3.5A and PAN600-2A do not offer master-slave control and serial operation functions.

Remote sensing

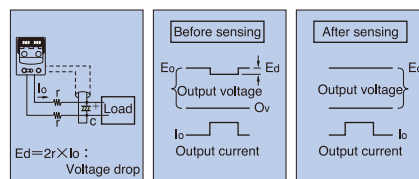

- This is a method used to compensate for the voltage drop caused by the cable resistance between the power unit and the load and contact resistance. The problem of voltage drops becomes more serious as the current becomes larger. By turning on the "Sens" switch at the rear panel and transferring the voltage sensing point to the load, a voltage drop of up to 0.6 V can be prevented on one side.

Note: For the sensing function in 16 V models, the maximum output voltage of this series is 105% of the rated voltage. Since the maximum output voltage of the 16 V models is 16.8 V, an attempt to compensate for 1.2 V (0.6 V for one way \times 2), the full-compensating voltage, will disable output of the rated voltage. In this case, use wires that have a larger cross-sectional area with less voltage drop, so that voltage drops are 0.4 V or less one-way.

- Connect an electrolytic capacitor with a capacity of a several thousand to several tens of thousand of microfarads to the load end, paying attention to the polarity and making the lead wires as short as possible. The reasoning here is as follows. A long cable to the load has nonnegligible inductance, which raises the output impedance of the power supply unit to the load. A large capacitance connected to the load end can prevent this. Particularly when dealing with a load like an inverter, which turns the current on and off with high frequency, connect a capacitor with a capacity larger than several thousand microfarad using the shortest possible lead wires.

Computer Control

- To control the power supply from a PC via a GPIB interface, connect a PIA4800 series power supply controller to a PAN-A series power supply.
 - * Combine the PIA4810 power supply controller and OP01-PIA or OP02-PIA control board for two-channel analog control with the PIA4800 series. Since the PIA4810 controller incorporates four control boards, up to eight channels of DC power supplies or loads can be controlled.



◀ A combination of the PAN-A series and a PIA4800 series power supply controller allows the extension of a system power supply.

Protection system

Failures or malfunctions of a power supply unit may cause an operational shut-down of the overall system or damages to expensive loads. Therefore, failure-free operating performance is extremely important. And should a failure occur, protection circuits must be provided that can ensure that no accident occurs.

■ Overvoltage protector (OVP)

If an overvoltage is generated by an operating error or accident, the OVP instantaneously (Operating time: 50 ms or less) shuts down the power switch circuit protector, and protects the connected load. (Type 0 and Type I2 models employ a gate block system, and shut down their rectification circuits.) Since the OVP used in the PAN-A series is of a preset design, the operating voltage can be preset by pressing the preset knob on the panel, while looking at the voltmeter. The operating voltage can be checked without interrupting the OVP operation even during aging.

■ Overheat protection circuit

This circuit functions to turn off the power switch, if the temperature of some of the main components in the equipment rises higher than a specified value.

A thermal fuse incorporated in the main- or sub-transformer further improves safety performance.

■ Voltage detection circuit

If the smoothing electrolytic capacitor voltage rises above a specified level owing to an operating error involving the remote selection switch inside the panel or to a failure of the rectification circuit, the voltage detection circuit functions to instantaneously shut down the rectification circuit.

■ Surge absorber

This protect the power supply unit from surge currents generated in the power line by lightning.

■ Reverse connection prevention circuit

This circuit protects the power supply unit even if a reverse polarity voltage is applied to the output terminals.

■ Overcurrent detection circuit

Using a comparison amplifier, this detection circuit constantly monitors the output current. It prevents a current from increasing beyond the rated value in the event of an over-input caused by remote control, and also prevents overcurrents caused by misoperation of the remote control selector located inside the panel.

Load

Since the PAN-A series is designed for a wide range of applications, there are a variety of loads to be connected. Depending on the type of load, direct connection may cause problems or malfunctions, and some countermeasures should be taken.

■ Load with accumulated energy, such as a battery

When connecting a load with accumulated energy, such as a battery, to the PAN-A series output, a large current may flow from the load to the internal capacitor through the output control circuit protection diode. This current may burn internal components or shorten the load's life. In such a case, therefore, connect a reverse current protection diode between the power supply unit and the load as shown below.

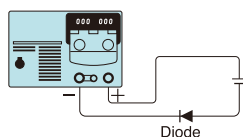

■ When the load current has peaks or a pulse waveform

In the case of a digital or a motor driving circuit, a load current waveform will instantaneously reach the rated current range if the peak value exceeds the rated value, even if it is within the rated value on the meter indication (mean value). If so, the output voltage will drop and appear unstable. The basic remedy is to increase the output current (i.e., increase the current preset value or current capacity). However, if the pulse width is narrow or the peak value is low, it may prove effective to connect a large-capacitor to the load end.

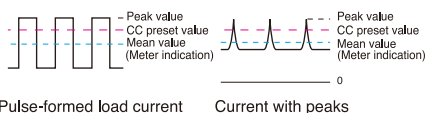

■ Inductive load

- The counter electromotive force generated by turning on and off of the power supply, or changing the voltage setting is shunted by protection diode D_1 inserted in parallel with the output so that the power supply is not damaged.
- When pulse noise generated from an inductive load is impressed at the same

polarity as the power supply, protect the power supply by inserting diode D_2 in series with the power supply and inserting a noise prevention CR absorber across the switch.

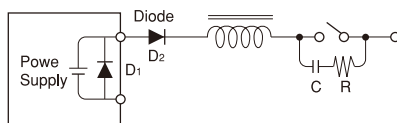

■ When the output is turned On and off with a mechanical switch

- When a DC output of 100 V or more is opened and closed with a switch, arc discharge, etc. will cause the switch contacts to noticeably wear and generate noise. This noise may enter the power supply differential amplifier through the load line and cause the output to become unstable. Take noise countermeasures by inserting a CR absorber near the contacts, the same as for an inductive load.
- When performing remote sensing, always turn the sensing line on or off simultaneously.

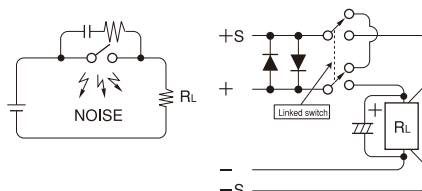

Rush Current

When turning on the power, a rush current may flow, depending on when the power is turned on. Such rush currents are caused by magnetic saturation of the transformer core material. Theoretically, if the power is turned on near the phase angle $90^\circ(\pi/2)$ of the voltage waveform, no rush current is generated. If the power is turned on at a timing corresponding to the phase angle 0° (zero cross), however, a max. current is generated. This transient phenomenon is shown below. In practice, however, the presence of a rush current is determined by the hysteresis characteristic of the B-H curve of the core material, the direction of residual magnetic flux upon switch-off, and/or the impedance of the AC line to which the PAN-A series is connected. If the power is turned on simultaneously for a multiple number of the PAN-A series units, check that the AC line capacity or the switch board capacity is sufficient.

- Typical (max.) rush current value for the PAN-A series
(Half wave width of current waveform: approx. 5 ms)

Type	175W(0)	350W(I2)	700W(I3)	1000W(II)
AC input power voltage	100 V	100 V	100 V	100 V
Peak current	100 A	200 A	350 A	450 A

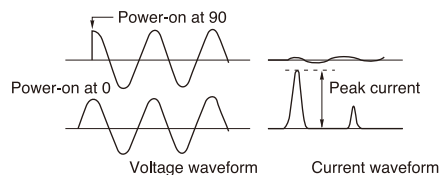

Negative voltage

With the OUTPUT switch set to OFF, a negative voltage of approx. 0.6 V is applied to the output when the current setting knob is turned completely counterclockwise. This voltage acts to generate approx. 10 mA of reverse current through the load. The PAN-A series may be inadequate for applications in which the load should be kept free from serious influence by such a reverse current.

Output terminals on the front side

The output terminals on the front side are auxiliary output terminals. These terminals may not satisfy the specification. To satisfy the specification, use output terminals on the rear panel. Be sure to use the attached terminal cover for models with rated output voltage higher than 55 V.

Output wires

The sectional area, current capacity, and resistance of these wires are as shown below.

Nominal sectional area	Current estimated for DC output wire
2(mm ²)	10(A)
5.5	20
8	30
14	50

Current for allowable conductor temperature 60°C(Ambient temperature 30°C)	Typical resistance at 20°C
27(A)	Approx. 9(Ω/km)
49	3
61	2.2
88	1.2

Model Line-up and Specifications

Model	Output		Ripple		Line Regulation		Load Regulation		Dimensions	Weight	Input	
	CV	CC	CV	CC	CV	CC	CV	CC	Type	kg/lb	Voltage(AC)	Power consumption
	V	A	mV rms	mA rms	0.005 %+mV	mA	0.005 %+mV	mA			V	Approx. kVA
PAN 16-10A	0 to 16	0 to 10	0.5	2	1	1	1	3	0	11/24.25	100	0.4
PAN 16-18A		0 to 18	0.5	5	1	1	1	3	I ₂	17/37.48	100	0.8
PAN 16-30A		0 to 30	0.5	5	1	3	2	3	I ₃	23/50.71	100	1.1
PAN 16-50A		0 to 50	0.5	10	1	3	2	5	II	36/79.37	100	1.6
PAN 35-5A	0 to 35	0 to 5	0.5	1	1	1	1	2	0	11/24.25	100	0.4
PAN 35-10A		0 to 10	0.5	2	1	1	1	3	I ₂	17/37.48	100	0.8
PAN 35-20A		0 to 20	0.5	3	1	3	2	3	I ₃	23/50.71	100	1.4
PAN 35-30A		0 to 30	0.5	5	1	3	1	5	II	36/79.37	100	1.8
PAN60-3A	0 to 60	0 to 3	0.5	1	1	1	1	2	0	11/24.25	100	0.35
PAN60-6A		0 to 6	0.5	2	1	1	1	3	I ₂	17/37.48	100	0.7
PAN60-10A		0 to 10	0.5	3	1	3	2	3	I ₃	22/48.5	100	1.1
PAN60-20A		0 to 20	0.5	2	1	1	1	2	II	35/77.16	100	2.1
PAN70-2.5A	0 to 70	0 to 2.5	0.5	1	1	1	1	1	0	11/24.25	100	0.35
PAN70-5A		0 to 5	0.5	2	1	1	1	2	I ₂	17/37.48	100	0.8
PAN70-8A		0 to 8	1	2	1	1	1	3	I ₃	22/48.5	100	1.1
PAN70-15A		0 to 15	1	5	1	1	1	3	II	35/77.16	100	1.9
PAN110-1.5A	0 to 110	0 to 1.5	0.5	1	1	1	1	1	0	11/24.25	100	0.4
PAN110-3A		0 to 3	0.5	1	1	1	1	2	I ₂	17/37.48	100	0.7
PAN110-5A		0 to 5	1	1	1	1	1	2	I ₃	22/48.5	100	1.0
PAN110-10A		0 to 10	1	2	1	1	1	3	II	35/77.16	100	2.0
PAN160-1A	0 to 160	0 to 1	1	1	1	1	1	1	0	11/24.25	100	0.33
PAN160-2A		0 to 2	1	1	1	1	1	2	I ₂	17/37.48	100	0.7
PAN160-3.5A		0 to 3.5	1	1	1	1	2	2	I ₃	22/48.5	100	1.0
PAN160-7A		0 to 7	1	2	1	1	2	2	II	36/79.37	100	1.9
PAN250-2.5A	0 to 250	0 to 2.5	5	2	2	1	3	1	I ₃	23/50.71	100	1.1
PAN250-4.5A		0 to 4.5	5	2	2	1	3	2	II	35/77.16	100	1.8
PAN350-3.5A	0 to 350	0 to 3.5	1	2	1	1	1	2	II	36/79.37	100	2.1
PAN600-2A	0 to 600	0 to 2	1	0.5	0.002 %+1	0.5	0.002 %+1	1	II	37/81.57	100	2.0

Input voltage: 110 VAC, 120 VAC, 200 VAC, 220 VAC, 230 VAC and 240 VAC input are available at request.

Common specifications

Constant voltage temperature coefficient 100 p.p.m./°C (standard value)
 Constant current temperature coefficient 300 p.p.m./°C (standard value)
 Transient response time 50 μs: Time required for the output voltage to return to a value less than 0.05 % of the rated value + 10 mV, against a fluctuation of 5 % to 100 % of the output current.
 Ripple noise Using an AC voltmeter having a range of 5 Hz to 1 MHz, ±3 dB, indicated in mean value and effective value measurement is performed with either a positive or negative output terminal connected to the ground.
 Indication meters
 Voltmeter indication error... ±(0.5 % rdg + 2 digits) at 23 °C ±5 °C
 Voltmeter max. indication digits.. 199.9 (Note: 199.9 for the PAN16-10A/PAN16-18A/PAN16-30A/PAN16-50A models, and 1999 for the PAN250-2.5A/PAN250-4.5A/PAN600-2A)
 Amperemeter indication error.. ±(1 % rdg + 5 digits) at 23 °C ±5 °C
 Amperemeter max. indication digits.. 19.99 (Note: 1.999 for the PAN110-1.5A/PAN160-1A, and 199.9 for the PAN16-30A/PAN16-50A/PAN35-20A/PAN35-30A/PAN60-20A)
 Grounding..... Either the positive or negative terminal can be grounded.
 Isolation voltage to ground.. ±250 VDC (However, ±500 VDC for the PAN110-1.5A/PAN110-3A/PAN110-5A/PAN110-10A/PAN160-1A/PAN160-2A/PAN160-3.5A/PAN250-2.5A/PAN250-4.5A.)

Insulation resistance..... Across input side and chassis:
 Greater than 30 MΩ at 500 VDC
 Across output side and chassis:
 Greater than 20 MΩ at 500 VDC
 (For PAN350-3.5A and PAN600-2A, this is 1000 V DC, 20 MΩ, or higher.)
 Withstand voltage..... Nothing abnormal should occur at 1500 VAC, 1 min.
 Operating temperature..... 0 to 40°
 Operating humidity..... 10 to 90 % RH
 Cooling system..... Forced air cooling using a fan
 Constant voltage operation.. Green LED
 Constant current operation.. Red LED
 Protection system ● Constant voltage/current automatic crossover system
 ● Overvoltage protector (OVP) (10 % to 110 % of rated output voltage)
 ● Overcurrent protection circuit (Approx. 110 % of rated output current)
 ● Overvoltage protection circuit (Smoothing electrolytic capacitor for the rectification circuit)
 ● Overheat protection circuit (OHP) (Semiconductor cooling heat-sink [100 °C])
 ● Thermal fuse (Main- or sub-transformer)
 ● Input/output fuse

External View (Rack Mount)

175 W Type (Type 0)

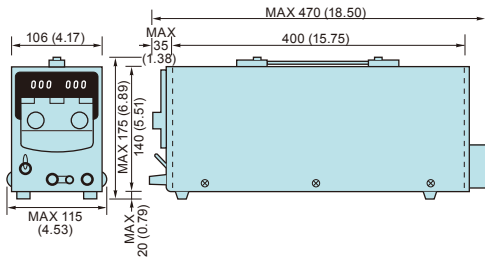

Output..... (Rear) Terminal M4
(Front) Binding post M6(auxiliary output terminal)
Input..... AC inlet
Attached power cable..... SVT3 × 18AWG, approx. 3m long, with 3P plug
(CE Model) (H05VV-F, 1SQ. mm, approx. 2m long)*

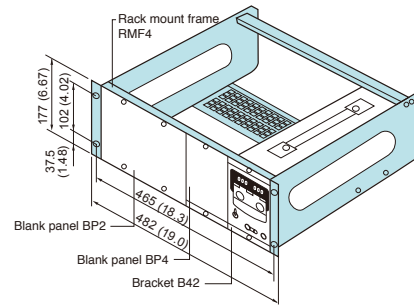

• Caution for mounting
When mounting on the rack, note that the power supply unit has an air intake for forced cooling. It is necessary to accompany a blank panel of width of one panel or larger with the unit.

350 W Type/700 W Type (Type 1₂/1₃)

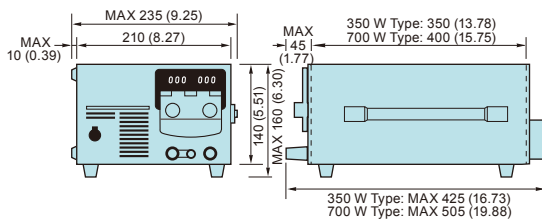

Output..... (Rear) Terminal M4
(Front) Binding post M8(auxiliary output terminal)
Input..... 350 W Type: AC inlet
700 W Type: Terminal M4
Attached power cable..... 350 W Type: SVT3 × 18AWG, approx. 3 m long, with 3P plug
(CE Model) (H05VV-F, 1SQ. mm, approx. 2m long)*
700 W Type: Nominal sectional area 2.0 SQ. mm, cabtyre cable, with 3P plug, approx. 3 m long (For PAN35-20A: Normal sectional area 3.5 SQ. mm, cabtyre cable, approx. 3 m long)
(CE Model) (H05VV-F, 1SQ. mm, approx. 2.5m long, PAN35-20A: H05VV-F, 2SQ. mm, approx. 3m long)*

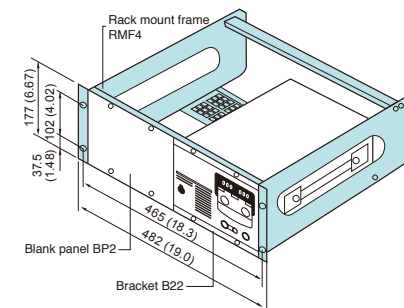

• Caution for mounting
When mounting on the rack, note that the power supply unit has an air intake for forced cooling. It is necessary to accompany a blank panel of width of one panel or larger with the unit.

1000 W Type (Type II)

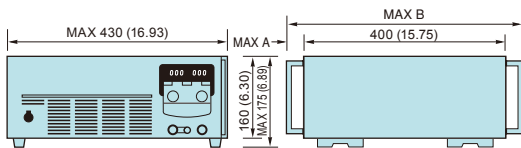

Model	MAX A	MAX B
PAN16-50A	40 (1.57)	500 (19.69)
PAN35-30A	45 (1.77)	505 (19.88)
PAN60-20A		
PAN70-15A		
PAN110-10A		
PAN160-7A		
PAN250-4.5A		
PAN350-3.5A		
PAN600-2A		

Output..... (Rear) Terminal M4 (M5 for PAN16-50A)
(Front) Binding post M8(auxiliary output terminal)
Input..... Terminal M4
Attached power cable..... Nominal sectional area 3.5 SQ. mm, cabtyre cable, without plug, approx. 3 m long
(CE Model) (H05VV-F, 2SQ. mm, approx. 3m long)*
Note: There is no auxiliary output terminal, on the front panel of Model PAN16-50A.

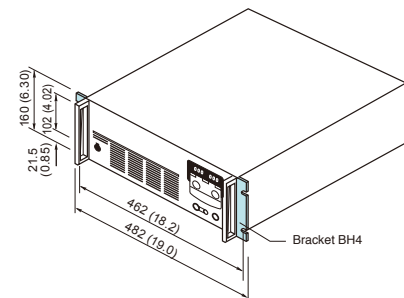

• Caution for mounting
When mounting on the rack, note that the power supply unit has an air intake for forced cooling. It is necessary to accompany a blank panel of width of one panel or larger with the unit.
*The CE marking products are only available for inline voltage of AC 230 V only.



KIKUSUI ELECTRONICS CORPORATION

1-1-3, Higashiyamata, Tsuzuki-ku, Yokohama, Kanagawa, 224-0023, Japan
Phone: (+81)45-593-0200, Facsimile: (+81)45-593-7591, <https://global.kikusui.co.jp/>

KIKUSUI AMERICA, INC. 1-310-214-0000 www.kikusuiamerica.com

3625 Del Amo Blvd, Suite 160, Torrance, CA 90503
Phone : 310-214-0000 Facsimile : 310-214-0014

KIKUSUI TRADING (SHANGHAI) Co., Ltd. www.kikusui.cn

Room 305, Shenggao Building, No.137, Xianxia Road, Shanghai City, China
Phone : 021-5887-9067 Facsimile : 021-5887-9069

For our local sales distributors and representatives, please refer to "sales network" of our website.

Printed in Japan

●Distributor:

■ All products contained in this catalogue are equipment and devices that are premised on use under the supervision of qualified personnel, and are not designed or produced for home-use or use by general consumers.
■ Specifications, design and so forth are subject to change without prior notice to improve the quality. ■ Product names and prices are subject to change and production may be discontinued when necessary. ■ Product names, company names and brand names contained in this catalogue represent the respective registered trade name or trade mark. ■ Colors, textures and so forth of photographs shown in this catalogue may differ from actual products due to a limited fidelity in printing. ■ Although every effort has been made to provide the information as accurate as possible for this catalogue, certain details have unavoidably been omitted due to limitations in space. ■ If you find any misprints or errors in this catalogue, it would be appreciated if you would inform us. ■ Please contact our distributors to confirm specifications, price, accessories or anything that may be unclear when placing an order or concluding a purchasing agreement.