



**P A V S E R I E S**



**COMPACT  
2U  
SIZE**

Versatile  
communication  
features

**LAN\***  
**USB**  
**RS232C/485**

CG Images.

\* LAN is a factory option

**COMPACT DC POWER SUPPLY**

**Smart Variable-switching DC Power Supply**

**PAV Series**



2U bench-top type  
Palm-sized, portable power supply  
Output power: 200 W / 400 W / 600 W / 800 W 4 models  
Output voltage: 10 V to 650 V 8 models  
LAN\*/USB/RS232C/RS485 as standard features (\*LAN is a factory option)  
64 models total (LAN model included)



# Small Size, Large Capability!

## Smart Variable-switching Regulated DC Power Supply

# PAV Series

### Palm-sized with maximum power output at 800 W.

The PAV series is a compact, high power density, high performance constant voltage (CV) / constant current (CC) variable switching power supply. The PAV consists of 64 models total\*1 with 4 types of maximum power outputs at 200 W, 400 W, 600 W and 800 W and output voltages from 10 V through 650 V. All models are standardized to a same size with 2U high (approximately 88 mm) and have high power density for bench-top use. The PAV series allows sequence settings with an embedded CPU as well as analog control.

Parallel operation (up to 6 units)\*2 and synchronized operation features are employed to allow extended output current. The PAV series is equipped standard with USB, RS232C and RS485 as communication interfaces which are essential for system upgrades. LAN\*3 interface is also available as an option. A harmonic current control circuit is embedded with a power factor of 0.99 to take power environment into account.

\*1 LAN model included (with LAN) \*2 The PAV series with the same rating \*3 factory option



Front Panel

**Actual size**

### ● Series line-up

Type	Specifications Model	Output		Ripple		Line regulation		Load regulation		Dimensions Type	Weight Approx. kg (lbs)	AC input	
		CV V	CC A	CV mVrms	CC mArms	CV mV	CC mA	CV mV	CC mA			voltage V	current* A
200W	PAV10-20	0 to 10	0 to 20	5	25	0.01%+2	0.01%+2	0.01%+2	0.01%+5	I	1.9 (4.2)	85 to 265	2.65/1.31
	PAV20-10	0 to 20	0 to 10	6	15	0.01%+2	0.01%+2	0.01%+2	0.01%+5	I	1.9 (4.2)	85 to 265	2.62/1.29
	PAV36-6	0 to 36	0 to 6	6	8	0.01%+2	0.01%+2	0.01%+2	0.01%+5	I	1.9 (4.2)	85 to 265	2.76/1.37
	PAV60-3.5	0 to 60	0 to 3.5	7	4	0.01%+2	0.01%+2	0.01%+2	0.01%+5	I	1.9 (4.2)	85 to 265	2.69/1.33
	PAV100-2	0 to 100	0 to 2	8	3	0.01%+2	0.01%+2	0.01%+2	0.01%+5	I	1.9 (4.2)	85 to 265	2.55/1.26
	PAV160-1.3	0 to 160	0 to 1.3	10	1.2	0.01%	0.02%	0.01%	0.09%	II	1.9 (4.2)	85 to 265	2.64/1.30
	PAV320-0.65	0 to 320	0 to 0.65	25	0.8	0.01%	0.02%	0.01%	0.09%	II	1.9 (4.2)	85 to 265	2.64/1.30
	PAV650-0.32	0 to 650	0 to 0.32	60	0.5	0.01%	0.02%	0.01%	0.15%	II	1.9 (4.2)	85 to 265	2.64/1.30
400W	PAV10-40	0 to 10	0 to 40	5	70	0.01%+2	0.01%+2	0.01%+2	0.01%+5	I	1.9 (4.2)	85 to 265	5.05/2.47
	PAV20-20	0 to 20	0 to 20	6	40	0.01%+2	0.01%+2	0.01%+2	0.01%+5	I	1.9 (4.2)	85 to 265	4.98/2.45
	PAV36-12	0 to 36	0 to 12	6	15	0.01%+2	0.01%+2	0.01%+2	0.01%+5	I	1.9 (4.2)	85 to 265	5.25/2.57
	PAV60-7	0 to 60	0 to 7	7	8	0.01%+2	0.01%+2	0.01%+2	0.01%+5	I	1.9 (4.2)	85 to 265	5.10/2.50
	PAV100-4	0 to 100	0 to 4	8	3	0.01%+2	0.01%+2	0.01%+2	0.01%+5	I	1.9 (4.2)	85 to 265	4.80/2.37
	PAV160-2.6	0 to 160	0 to 2.6	10	1.5	0.01%	0.02%	0.01%	0.09%	II	1.9 (4.2)	85 to 265	5/2.44
	PAV320-1.3	0 to 320	0 to 1.3	25	1	0.01%	0.02%	0.01%	0.09%	II	1.9 (4.2)	85 to 265	5/2.44
	PAV650-0.64	0 to 650	0 to 0.64	60	0.6	0.01%	0.02%	0.01%	0.09%	II	1.9 (4.2)	85 to 265	5/2.44

\*Input voltage 100 Vac/200 Vac, at the rated output power, ambient temperature 25°C, If the LAN option is built in, the efficiency decreases by 0.5% and the input current increases by 0.5%.



PAV SERIES

**Embedded standard communication interfaces**  
**New regular testing power supply with high performance switching system**



- **Ultra-compact high power**  
 19 inch rack-mount (max 6 units)  
 200 W / 400 W / 600 W / 800 W models available.
- **Standard Communication Interface**  
 LAN\*, USB, RS232C, and RS485 as standard communication interfaces. \*LAN is a factory option
- **Multi-output system configuration**  
 A variable power supply system of up to 31 channels can be configured using the built-in LAN / USB / RS232 / RS485 ports.
- **Parallel operation**  
 Parallel operation is possible using several PAV series power supplies with the same voltage and current ratings (up to six using master-slave parallel connection with output current balance function).
- **Application software**  
 Sequence Creation Software  
 Wavy for PAV (SD024-PAV)

**Rear Panel**  
 Models whose rated output voltage is 10 V to 100 V LAN model

Type	Specifications Model	Output		Ripple		line regulation		load regulation		Dimensions Type	Weight Approx. kg (lbs)	AC input	
		CV	CC	CV	CC	CV	CC	CV	CC			voltage	current*
		V	A	mVrms	mArms	mV	mA	mV	mA			V	A
600W	PAV10-60	0 to 10	0 to 60	5	150	0.01%+2	0.01%+2	0.01%+2	0.01%+5	I	2.1 (4.6)	85 to 265	7.48/3.69
	PAV20-30	0 to 20	0 to 30	5	75	0.01%+2	0.01%+2	0.01%+2	0.01%+5	I	2.1 (4.6)	85 to 265	7.22/3.56
	PAV36-18	0 to 36	0 to 18	5	25	0.01%+2	0.01%+2	0.01%+2	0.01%+5	I	2.1 (4.6)	85 to 265	7.70/3.80
	PAV60-10	0 to 60	0 to 10	12	8	0.01%+2	0.01%+2	0.01%+2	0.01%+5	I	2.1 (4.6)	85 to 265	7.13/3.52
	PAV100-6	0 to 100	0 to 6	15	5	0.01%+2	0.01%+2	0.01%+2	0.01%+5	I	2.1 (4.6)	85 to 265	7.13/3.52
	PAV160-4	0 to 160	0 to 4	10	2	0.01%	0.02%	0.01%	0.09%	II	2 (4.4)	85 to 265	7.47/3.69
	PAV320-2	0 to 320	0 to 2	30	1.5	0.01%	0.02%	0.01%	0.09%	II	2 (4.4)	85 to 265	7.47/3.69
	PAV650-1	0 to 650	0 to 1	60	1	0.01%	0.02%	0.01%	0.09%	II	2 (4.4)	85 to 265	7.59/3.75
800W	PAV10-72	0 to 10	0 to 72	5	180	0.01%+2	0.01%+2	0.01%+2	0.01%+5	I	2.1 (4.6)	85 to 265	9.00/4.45
	PAV20-40	0 to 20	0 to 40	5	100	0.01%+2	0.01%+2	0.01%+2	0.01%+5	I	2.1 (4.6)	85 to 265	9.65/4.75
	PAV36-24	0 to 36	0 to 24	5	31	0.01%+2	0.01%+2	0.01%+2	0.01%+5	I	2.1 (4.6)	85 to 265	10.30/5.10
	PAV60-14	0 to 60	0 to 14	12	28	0.01%+2	0.01%+2	0.01%+2	0.01%+5	I	2.1 (4.6)	85 to 265	10.00/4.95
	PAV100-8	0 to 100	0 to 8	15	12	0.01%+2	0.01%+2	0.01%+2	0.01%+5	I	2.1 (4.6)	85 to 265	9.5/4.7
	PAV160-5	0 to 160	0 to 5	10	2	0.01%	0.02%	0.01%	0.09%	II	2 (4.4)	85 to 265	9.34/4.61
	PAV320-2.5	0 to 320	0 to 2.5	30	1.5	0.01%	0.02%	0.01%	0.09%	II	2 (4.4)	85 to 265	9.34/4.59
	PAV650-1.25	0 to 650	0 to 1.25	60	1	0.01%	0.02%	0.01%	0.09%	II	2 (4.4)	85 to 265	9.43/4.66

\*Input voltage 100 Vac/200 Vac, at the rated output power, ambient temperature 25°C, If the LAN option is built in, the efficiency decreases by 0.5% and the input current increases by 0.5%.

# Versatile external control applications

Analog control/monitoring terminals support various applications.

## Remote sensing

These features compensate voltage drops in wires from the output terminals to the load terminals of the PAV series.

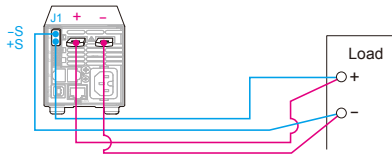

## Output voltage/current remote monitoring and CV/CC signals

Voltages from 0 V to 5 V or 0 V to 10 V are output proportionally to the output voltage/current from the PAV series. The operation state becomes HIGH in CV constant voltage mode and LOW in CC constant current mode.

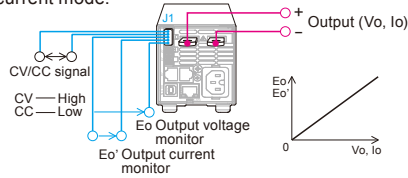

## Master-slave parallel operation

The PAV series allows up to 6 parallel connections to increase the output current.

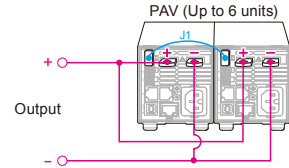

## Output voltage and output current control using external voltage

It is possible to control the output voltage/output current of the PAV series by using an external voltage.

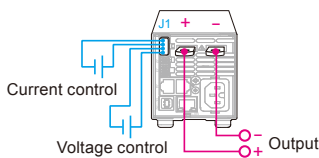

## Output on/off control

It is possible to turn the output ON/OFF of the PAV series by using an external contact.

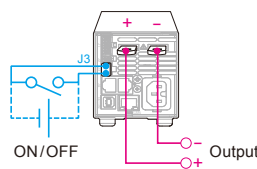

## Daisy chain connection

A multiple power supply system configured with more than one PAV series allows to create a multi-power supply system that stops all the power supply outputs if any power supply fails.

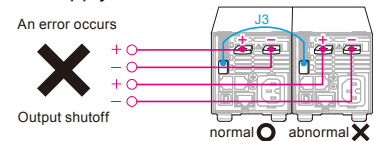

## Output voltage and output current control using external resistance

It is possible to control the output voltage/output current of the PAV series by using an external variable resistor.

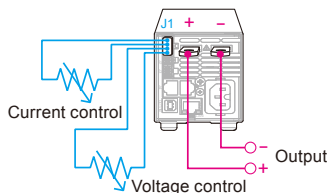

## Series operation

You can connect PAV series with the same rating in series to increase the output voltage. (up to 2 units) Dual output configuration is also supported.

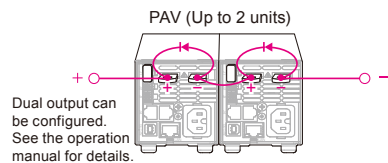

Models whose rated output voltage is 10 V, 20 V or 36 V : ±60 Vdc or less  
Models whose rated output voltage is 10 V or 100 V : ±100 Vdc or less  
Models whose rated output voltage is 160 V, 320 V, or 650 V : ±650 Vdc or less

## PS\_OK signal

A failure is notified by a TTL level signal if the protection function is activated. The PS\_OK level is HIGH in normal operating state.

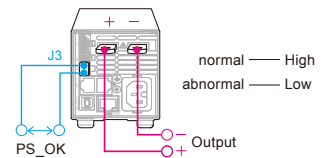

## J1 connector specifications

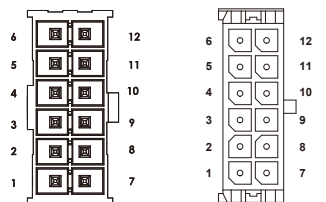

Models whose rated output voltage is 10 V to 100 V

Models whose rated output voltage is 160 V to 650 V

### ●Signals and functions

Pin no.	Signal name	Function
1	LOC/REM SELECT	Local/remote switching
2	P	Current balance terminal for master-slave parallel operation
3	I_MON	Output current monitoring terminal
4	LOC/REM MON	Local/remote status output
5	IPGM	Output current control using external voltage or external resistance
6	VPGM	Output voltage control using external voltage or external resistance
7	COM	Common ground for VMON, IMON, CV/CC, and LOC/REM signals (connected internally to the negative sensing terminal (-S))
8	CV/CC	Constant voltage/constant current operation mode indication terminal (The ground is COM.)
9	COM	Common ground for VMON, IMON, CV/CC, and LOC/REM signals (connected internally to the negative sensing terminal (-S))
10	V_MON	Output voltage monitoring terminal
11	IPGM_RTN	Ground for IPGM
12	VPGM_RTN	Ground for VPGM (connected internally to the negative sensing terminal (-S))

## J3 connector specifications

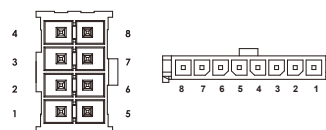

Models whose rated output voltage is 10 V to 100 V

Models whose rated output voltage is 160 V to 650 V

### ●Signals and functions

Pin no.	Signal name	Function
1	Aux Pin 1	General-purpose open collector output (1)
2	PS_OK	Status output terminal indicating the output state (on/shut off)
3	Trigger Out	Trigger output terminal
4	ILC	Output on/off control input terminal Output on when shorted; output off when open (isolated from the output)
5	Shut Off (SO)	Output shutoff control terminal (isolated from the output)
6	Aux Pin 2	General-purpose open collector output (2)
7	IFC_COM	J3 common ground (isolated from the output)
8	Trigger In	Trigger input terminal

## ■ USB/RS232C/RS485 Control

The PAV series employs USB/RS232C/RS485 interfaces as a standard. Up to 31 PAV series power supplies can be connected and controlled. The USB/RS232C/RS485 interfaces are integrated in the PAV series main body.

Allows control of up to 31 power supplies.

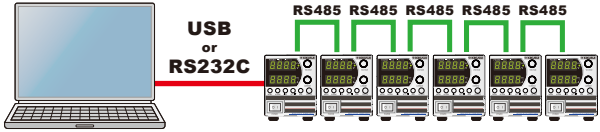

## ■ Parallel operation/Synchronized operation

Parallel operation (PAV series with the same rating) and synchronized operation (trigger synchronization) are available. Use of optional rack-mount adapter KRA2-PAV (allows up to 6 units) and half-size integrated chassis cover CC01- PAV (allows up to 3 units) allows integration for smart rack mounting and transportation.

\*Parallel operation and synchronized operation can be achieved without the optional KRA2-PAV and CC01-PAV.

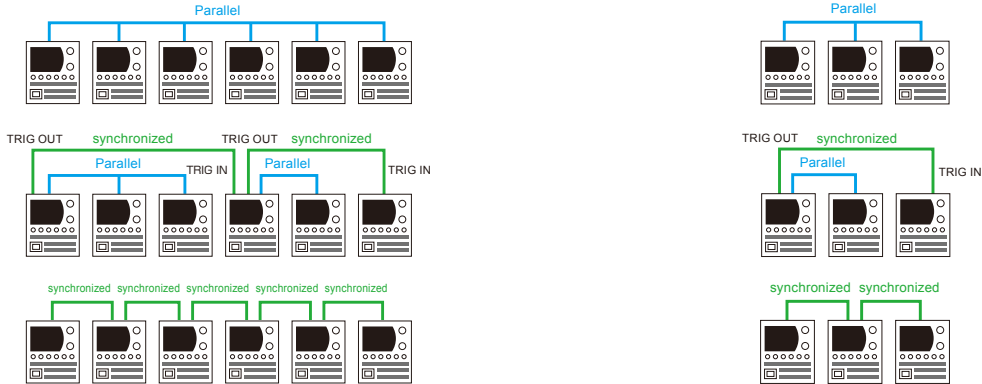

● example of using option

Up to 4.8 kW (up to 6 units) can be mounted into a 19-inch general-purpose rack



KRA2-PAV (e.g. 6 units are mounted)

\*Vacant slot without a power supply allows the mounting of an optional blank panel (KBP2-6-PAV).

Three-in-one on the bench top is available



CC01-PAV (e.g. 3 units are mounted)

## ■ Application software

Sequence creation software Wavy for PAV (SD024-PAV)

The software that supports to the auto testing of the power supply. And it allows you to create and edit sequence data easily using a mouse !

The Wavy for PAV (SD024-PAV) is an application software that supports sequence creation and the operation of the Kikusui power supply. The "Wavy" software allows you to create and edit sequences visually using a mouse without programming knowledge. It enables you to control the power supply in much the same way as remote controller for such monitoring the voltage and current, logging and so on.

### [Operating environment, conditions]

- The "Wavy" software can control only one unit of the power supply.
- CPU:Recommended: Core2 or better
- CD-ROM: Required to install the "Wavy"
- Mouse: Required
- Monitor: 1024 x 768 dots or higher resolution
- Memory: 2 GB or more
- Interfaces: LAN, USB, RS232C

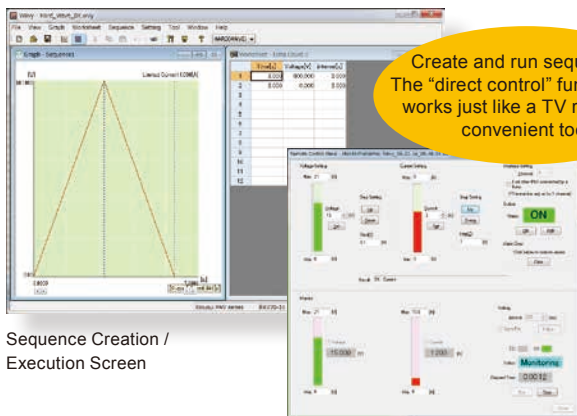

Create and run sequences! The "direct control" function that works just like a TV remote is convenient too!

Sequence Creation / Execution Screen

Direct Control Screen

## 200 W Type Specifications

200 W type	PAV 10-20	PAV 20-10	PAV 36-6	PAV 60-3.5	PAV 100-2	PAV 160-1.3	PAV 320-0.65	PAV 650-0.32	
<b>Output</b>									
Rated output voltage *1	10 V	20 V	36 V	60 V	100 V	160 V	320 V	650 V	
Rated output current *2	20 A	10 A	6 A	3.5 A	2 A	1.3 A	0.65 A	0.32 A	
Rated output power	200 W	200 W	216 W	210 W	200 W	208 W	208 W	208 W	
<b>AC input</b>									
Nominal input rating	100 Vac to 240 Vac continuous input, 50 Hz to 60 Hz, single phase								
Input voltage range	85 Vac to 265 Vac								
Input frequency range	47 Hz to 63 Hz								
Input current (typ) *3 (100 Vac/200 Vac)	2.65 A/1.31 A	2.62 A/1.29 A	2.76 A/1.37 A	2.69 A/1.33A	2.55 A/1.26 A	2.64 A/1.30 A			
Power factor (typ) (100 Vac/200 Vac, at the rated output power)	0.99 / 0.98								
Efficiency (typ) *3	76% / 77.5%	77% / 79%	79% / 80.5%	79% / 80.5%	79% / 81%	79% / 81%			
Inrush current (100 Vac/200 Vac) *4	15 A / 30 A or less					25 A / 25 A or less			
<b>Constant voltage mode</b>									
Maximum line regulation *5 (for the rated output voltage)	0.01% + 2 mV					0.01%			
Maximum load regulation *6 (for the rated output voltage)									
Ripple noise *7	20 MHz, p-p	50 mV	50 mV	50 mV	50 mV	80 mV	100 mV	150 mV	250 mV
	5 Hz to 1 MHz, rms	5 mV	6 mV	6 mV	7 mV	8 mV	10 mV	25 mV	60 mV
Temperature coefficient	30 PPM /°C (after a 30 minute warm-up, for the rated output voltage)								
Aging drift *8 (for the rated output voltage)	0.02%								
Initial drift *9 (for the rated output voltage)	0.05% + 2 mV					0.05%			
Maximum remote sensing compensation voltage (single line (positive or negative))	1 V	1 V	2 V	3 V	5 V	5 V			
Rise time *10	15 ms	30 ms	30 ms	50 ms	50 ms	110 ms	170 ms	170 ms	
Fall time	At full load *10	12 ms	25 ms	30 ms	40 ms	50 ms	180 ms	270 ms	270 ms
	Td (typ) *11	210 ms	250 ms	320 ms	380 ms	1200 ms	---		
	No load a *12	40 ms	65 ms	85 ms	100 ms	250 ms	---		
	No load b *13	200 ms	200 ms	290 ms	310 ms	1100 ms	2000 ms	2500 ms	3000 ms
Transient response time *14	1 ms or less					2 ms or less			
Output hold time (typ) *15	15 ms	16 ms				16 ms	16 ms	15 ms	
<b>Constant current mode</b>									
Maximum line regulation *5 (at the rated output current)	0.01% + 2 mA					0.02%			
Maximum load regulation *16 (at the rated output current)	0.01% + 5 mA					0.09%		0.15%	
Change in the load due to the temperature drift of internal components (at the rated output current)	0.05% or less (for 30 minutes after the load conditions are changed)								
Ripple noise *17 (5 Hz to 1 MHz, rms)	25 mA	15 mA	8 mA	4 mA	3 mA	1.2 mA	0.8 mA	0.5 mA	
Temperature coefficient	100 PPM /°C (after a 30 minute warm-up, at the rated output current)								
Aging drift *8 (at the rated output current)	0.05%								
Initial drift *9 (at the rated output current)	0.1%								
<b>Protection functions</b>									
Foldback protection	Turns off the output when the operation switches from constant voltage mode to constant current mode or vice versa. Can be set as necessary.								
Overvoltage protection (OVP)	Inverter shutoff system. Prevents the output voltage from being set higher than the OVP value. Also shuts off the output when an output overvoltage (exceeding the OVP value) occurs.								
Overvoltage protection voltage setting range	0.5 V to 12 V	1 V to 24 V	2 V to 40 V	5 V to 66 V	5 V to 110 V	5 V to 176 V	5 V to 353 V	5 V to 717 V	
Undervoltage limit (UVL)	Prevents the output voltage from being set lower than the UVL value. Disabled during external control.								
Undervoltage protection (UVP)	Shuts off the output when the output voltage falls below the UVP value.								
Overheat protection	Shuts off the output before the temperature of the internal components exceeds the safe operation temperature.								

# 200 W Type Specifications

200 W type		PAV 10-20	PAV 20-10	PAV 36-6	PAV 60-3.5	PAV 100-2	PAV 160-1.3	PAV 320-0.65	PAV 650-0.32	
Setting and readback (USB, RS232, RS485, optional LAN interface)										
Output voltage setting	Accuracy	0.05% of the rated output voltage					0.05% of the output voltage + 0.05% of the rated output voltage			
	Number of decimal digits	3 digits				2 digits				
	Resolution	Approx. 1/60000 of rated output voltage								
Output current setting	Accuracy *18	0.1% of output current + 0.1% of the rated output current					0.2% of the rated output current			
	Number of decimal digits	3 digits			4 digits					
	Resolution	Approx. 1/60000 of rated output current								
Output voltage readback	Accuracy	0.05% of the rated output voltage					0.05% of the output voltage + 0.05% of the rated output voltage			
	Resolution	Approx. 1/60000 of rated output voltage								
Output current readback	Accuracy *18	0.1% of output current + 0.3% of the rated output current								
	Resolution	Approx. 1/60000 of rated output current								
Front panel										
Control function	<ul style="list-style-type: none"> <li>● Separate knobs (encoders) for setting the output voltage and output current (setting resolution switchable).</li> <li>● Knobs (encoders) for setting OVP,UVP,and UVL.</li> <li>● Protection functions (OVP, UVP, UVL, foldback)</li> <li>● Output shutoff function (output on/off control, shutdown)</li> <li>● Communication functions: Standard equipped with USB, RS232, RS485. LAN optional.</li> <li>● Baudrate, address setting</li> <li>● External control: Configuration using external voltage (5 V or 10 V) or external resistance (5 kΩ or 10 kΩ), output voltage/current monitor output (5 V or 10 V), output on/off, front panel operation lock</li> </ul>									
Output voltage display	Accuracy	0.5% of the rated output voltage ± 1 count								
	Number of decimal digits	2 digits				1 digit				
Output current display	Accuracy	0.5% of the rated output current ± 1 count								
	Number of decimal digits	2 digits			3 digits					
LED display	Green: FINE, MENU, SET, ALARM, REM, OUTPUT, CV, CC Red: ALARM (OVP, UVP, OTP, FOLD, AC FAIL)									
Setting keys	FINE, MENU, SET, ALARM, REM, OUTPUT									

- \*1. The minimum voltage is 0.1 % of the rated output voltage.
- \*2. The minimum current is 0.2 % of the rated output current.
- \*3. Input voltage 100 Vac/200 Vac, at the rated output power, ambient temperature 25 °C  
If the LAN option is built in, the efficiency decreases by 0.5 % and the input current increases by 0.5 %.
- \*4. Excludes input surge current (duration 0.2 ms or less) applied to the built-in noise filter section.
- \*5. 85 Vac to 132 Vac or 170 Vac to 265 Vac, fixed load
- \*6. With the input voltage held constant, the sensing point was measured using remote sensing from no load to full load.
- \*7. Models with rated output voltages from 10 V to 100 V were measured using an RC-9131 A 1:1 probe that conforms to the JEITA specifications. Models with rated output voltage from 160 V to 650 V were measured using a 10:1 probe.
- \*8. When at least 8 hours has passed after a 30 minute warm-up with the input voltage, load, and ambient temperature held constant
- \*9. For 30 minutes after turning on the power with the input voltage, load, and ambient temperature held constant
- \*10. Between 10 % and 90 % of the rated resistive load and rated output voltage
- \*11. If the output voltage is repeatedly decreased, Td is the minimum duration from a given voltage drop to the next voltage drop.
- \*12. Duration for the voltage to change from 90 % to 10 % of the rated output voltage when the output voltage is repeatedly decreased and the duration from a given voltage drop to the next voltage drop is longer than Td.

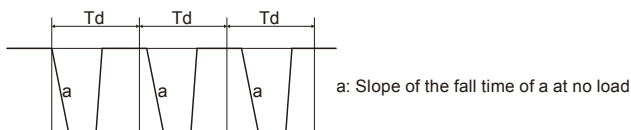

- \*13. Duration for the voltage to change from 90 % to 10 % of the rated output voltage when the output voltage is repeatedly decreased and the duration from a given voltage drop to the next voltage drop is shorter than Td.

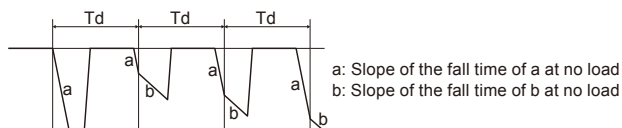

- \*14. The amount of time required for the output voltage to return to a value within 0.5 % of the rated output voltage. The change in the load current is 10 % to 90 % of the rating. The output voltage is between 10 % and 100 % of the rating. During local sensing.
- \*15. At the rated output power
- \*16. The value when the output voltage is changed from the lower limit to the rated voltage in constant current mode with the input voltage held constant
- \*17. For models with a 10 V rated output voltage, this is the value for when the output voltage is 2 V to 10 V at the rated output current. For other models, this is the value for when the output voltage is 10 % to 100 % of the rating at the rated output current. Models with rated output voltage from 160 V to 650 V were measured using a 10:1 probe.
- \*18. In output current control, the current, linearity, and monitor accuracies do not include the load variation caused by initial drift and temperature drift of internal components.

## 400 W Type Specifications

400 W type	PAV 10-40	PAV 20-20	PAV 36-12	PAV 60-7	PAV 100-4	PAV 160-2.6	PAV 320-1.3	PAV 650-0.64	
<b>Output</b>									
Rated output voltage *1	10 V	20 V	36 V	60 V	100 V	160 V	320 V	650 V	
Rated output current *2	40 A	20 A	12 A	7 A	4 A	2.6 A	1.3 A	0.64 A	
Rated output power	400 W	400 W	432 W	420 W	400 W	416 W	416 W	416 W	
<b>AC input</b>									
Nominal input rating	100 Vac to 240 Vac continuous input, 50 Hz to 60 Hz, single phase								
Input voltage range	85 Vac to 265 Vac								
Input frequency range	47 Hz to 63 Hz								
Input current (typ) *3 (100 Vac/200 Vac)	5.05 A/2.47 A	4.98 A/2.45 A	5.25 A/2.57 A	5.10 A/2.50 A	4.80 A/2.37 A	5 A / 2.44 A			
Power factor (typ) (100 Vac/200 Vac, at the rated output power)	0.99								
Efficiency (typ) *3	80% / 82%	81% / 83%	83% / 85%	83% / 85%	84% / 88%	84% / 86%			
Inrush current (100 Vac/200 Vac) *4	25 A / 25 A or less					25 A / 25 A or less			
<b>Constant voltage mode</b>									
Maximum line regulation *5 (for the rated output voltage)	0.01% + 2 mV					0.01%			
Maximum load regulation *6 (for the rated output voltage)									
Ripple noise *7	20 MHz, p-p	50 mV	50 mV	50 mV	50 mV	80 mV	100 mV	150 mV	250 mV
	5 Hz to 1 MHz, rms	5 mV	6 mV	6 mV	7 mV	8 mV	10 mV	25 mV	60 mV
Temperature coefficient	30 PPM /°C (after a 30 minute warm-up, for the rated output voltage)								
Aging drift *8 (for the rated output voltage)	0.02%								
Initial drift *9 (for the rated output voltage)	0.05% + 2 mV					0.05%			
Maximum remote sensing compensation voltage (single line (positive or negative))	1 V	1 V	2 V	3 V	5V	5 V			
Rise time *10	15 ms	30 ms	30 ms	50 ms	50 ms	80 ms	150 ms	150 ms	
Fall time	At full load *10	10 ms	10 ms	15 ms	30 ms	50 ms	100 ms	150 ms	150 ms
	Td (typ) *11	210 ms	250 ms	320 ms	380 ms	1200 ms	---		
	No load a *12	40 ms	65 ms	85 ms	100 ms	250 ms	---		
	No load b *13	200 ms	200 ms	290 ms	310 ms	1100 ms	2000 ms	2500 ms	3000 ms
Transient response time *14	1 ms or less					2 ms or less			
Output hold time (typ) *15	15 ms	16 ms				16 ms		15 ms	
<b>Constant current mode</b>									
Maximum line regulation *5 (at the rated output current)	0.01% + 2 mA					0.02%			
Maximum load regulation *16 (at the rated output current)	0.01% + 5 mA					0.09%			
Change in the load due to the temperature drift of internal components (at the rated output current)	0.05% or less (for 30 minutes after the load conditions are changed)								
Ripple noise *17 (5 Hz to 1 MHz, rms)	70 mA	40 mA	15 mA	8 mA	3 mA	1.5 mA	1 mA	0.6 mA	
Temperature coefficient	100 PPM /°C (after a 30 minute warm-up, at the rated output current)								
Aging drift *8 (at the rated output current)	0.05%								
Initial drift *9 (at the rated output current)	0.1%								
<b>Protection functions</b>									
Foldback protection	Turns off the output when the operation switches from constant voltage mode to constant current mode or vice versa. Can be set as necessary.								
Overvoltage protection (OVP)	Inverter shutoff system. Prevents the output voltage from being set higher than the OVP value. Also shuts off the output when an output overvoltage (exceeding the OVP value) occurs.								
Overvoltage protection voltage setting range	0.5 V to 12 V	1 V to 24 V	2 V to 40 V	5 V to 66 V	5 V to 110 V	5 V to 176 V	5 V to 353 V	5 V to 717 V	
Undervoltage limit (UVL)	Prevents the output voltage from being set lower than the UVL value. Disabled during external control.								
Undervoltage protection (UVP)	Shuts off the output when the output voltage falls below the UVP value.								
Overheat protection	Shuts off the output before the temperature of the internal components exceeds the safe operation temperature.								



# 400 W Type Specifications

400 W type		PAV 10-40	PAV 20-20	PAV 36-12	PAV 60-7	PAV 100-4	PAV 160-2.6	PAV 320-1.3	PAV 650-0.64	
Setting and readback (USB, RS232, RS485, optional LAN interface)										
Output voltage setting	Accuracy	0.05% of the rated output voltage					0.05% of the output voltage + 0.05% of the rated output voltage			
	Number of decimal digits	3 digits				2 digits				
	Resolution	Approx. 1/60000 of rated output voltage								
Output current setting	Accuracy *18	0.1% of output current + 0.1% of the rated output current					0.2% of the rated output current			
	Number of decimal digits	3 digits				4 digits				
	Resolution	Approx. 1/60000 of rated output current								
Output voltage readback	Accuracy	0.05% of the rated output voltage					0.05% of the output voltage + 0.05% of the rated output voltage			
	Resolution	Approx. 1/60000 of rated output voltage								
Output current readback	Accuracy *18	0.1% of output current + 0.3% of the rated output current								
	Resolution	Approx. 1/60000 of rated output current								
Front panel										
Control function	<ul style="list-style-type: none"> <li>● Separate knobs (encoders) for setting the output voltage and output current (setting resolution switchable).</li> <li>● Knobs (encoders) for setting OVP, UVP, and UVL.</li> <li>● Protection functions (OVP, UVP, UVL, foldback)</li> <li>● Output shutoff function (output on/off control, shutdown)</li> <li>● Communication functions: Standard equipped with USB, RS232, RS485. LAN optional.</li> <li>● Baudrate, address setting</li> <li>● External control: Configuration using external voltage (5 V or 10 V) or external resistance (5 kΩ or 10 kΩ), output voltage/current monitor output (5 V or 10 V), output on/off, front panel operation lock</li> </ul>									
Output voltage display	Accuracy	0.5% of the rated output voltage ± 1 count								
	Number of decimal digits	2 digits				1 digit				
Output current display	Accuracy	0.5% of the rated output current ± 1 count								
	Number of decimal digits	2 digits				3 digits				
LED display	Green: FINE, MENU, SET, ALARM, REM, OUTPUT, CV, CC Red: ALARM (OVP, UVP, OTP, FOLD, AC FAIL)									
Setting keys	FINE, MENU, SET, ALARM, REM, OUTPUT									

- \*1. The minimum voltage is 0.1 % of the rated output voltage.
- \*2. The minimum current is 0.2 % of the rated output current.
- \*3. Input voltage 100 Vac/200 Vac, at the rated output power, ambient temperature 25 °C  
If the LAN option is built in, the efficiency decreases by 0.5 % and the input current increases by 0.5 %.
- \*4. Excludes input surge current (duration 0.2 ms or less) applied to the built-in noise filter section.
- \*5. 85 Vac to 132 Vac or 170 Vac to 265 Vac, fixed load
- \*6. With the input voltage held constant, the sensing point was measured using remote sensing from no load to full load.
- \*7. Models with rated output voltages from 10 V to 100 V were measured using an RC-9131 A 1:1 probe that conforms to the JEITA specifications. Models with rated output voltage from 160 V to 650 V were measured using a 10:1 probe.
- \*8. When at least 8 hours has passed after a 30 minute warm-up with the input voltage, load, and ambient temperature held constant
- \*9. For 30 minutes after turning on the power with the input voltage, load, and ambient temperature held constant
- \*10. Between 10 % and 90 % of the rated resistive load and rated output voltage
- \*11. If the output voltage is repeatedly decreased, Td is the minimum duration from a given voltage drop to the next voltage drop.
- \*12. Duration for the voltage to change from 90 % to 10 % of the rated output voltage when the output voltage is repeatedly decreased and the duration from a given voltage drop to the next voltage drop is longer than Td.

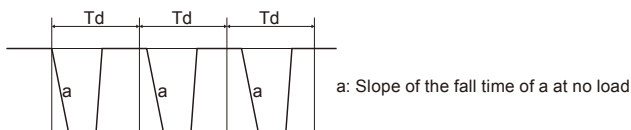

- \*13. Duration for the voltage to change from 90 % to 10 % of the rated output voltage when the output voltage is repeatedly decreased and the duration from a given voltage drop to the next voltage drop is shorter than Td.

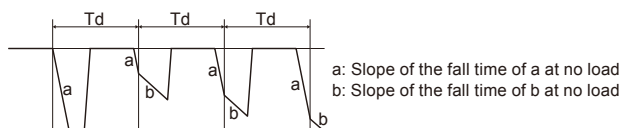

- \*14. The amount of time required for the output voltage to return to a value within 0.5 % of the rated output voltage. The change in the load current is 10 % to 90 % of the rating. The output voltage is between 10 % and 100 % of the rating. During local sensing.
- \*15. At the rated output power
- \*16. The value when the output voltage is changed from the lower limit to the rated voltage in constant current mode with the input voltage held constant
- \*17. For models with a 10 V rated output voltage, this is the value for when the output voltage is 2 V to 10 V at the rated output current. For other models, this is the value for when the output voltage is 10 % to 100 % of the rating at the rated output current. Models with rated output voltage from 160 V to 650 V were measured using a 10:1 probe.
- \*18. In output current control, the current, linearity, and monitor accuracies do not include the load variation caused by initial drift and temperature drift of internal components.

## 600 W Type Specifications

600 W type	PAV 10-60	PAV 20-30	PAV 36-18	PAV 60-10	PAV 100-6	PAV 160-4	PAV 320-2	PAV 650-1	
<b>Output</b>									
Rated output voltage *1	10 V	20 V	36 V	60 V	100 V	160 V	320 V	650 V	
Rated output current *2	60 A	30 A	18 A	10 A	6 A	4 A	2 A	1 A	
Rated output power	600 W	600 W	648 W	600 W	600 W	640 W	640 W	650 W	
<b>AC input</b>									
Nominal input rating	100 Vac to 240 Vac continuous input, 50 Hz to 60 Hz, single phase								
Input voltage range	85 Vac to 265 Vac								
Input frequency range	47 Hz to 63 Hz								
Input current (typ) *3 (100 Vac/200 Vac)	7.48 A/3.69 A	7.22 A/3.56 A	7.70 A/3.80 A	7.13 A/3.52 A	7.13 A/3.52 A	7.47 A / 3.69 A		7.59 A/3.75 A	
Power factor (typ) (100 Vac/200 Vac, at the rated output power)	0.99 / 0.98								
Efficiency (typ) *3	81% / 83%	84% / 86%	85% / 87%	85% / 87%	85% / 87%	86.5% / 88.5%	87% / 88.5%	86.5% / 88.5%	
Inrush current (100 Vac/200 Vac) *4	30 A / 30 A or less					30 A / 30 A or less			
<b>Constant voltage mode</b>									
Maximum line regulation *5 (for the rated output voltage)	0.01% + 2 mV					0.01%			
Maximum load regulation *6 (for the rated output voltage)									
Ripple noise *7	20 MHz, p-p	50 mV	50 mV	50 mV	50 mV	80 mV	100 mV	150 mV	250 mV
	5 Hz to 1 MHz, rms	5 mV	5 mV	5 mV	12 mV	15 mV	10 mV	30 mV	60 mV
Temperature coefficient	30 PPM /°C (after a 30 minute warm-up, for the rated output voltage)								
Aging drift *8 (for the rated output voltage)	0.05%					0.02%			
Initial drift *9 (for the rated output voltage)	0.05% + 2 mV					0.05%			
Maximum remote sensing compensation voltage (single line (positive or negative))	1 V	1 V	2 V	3 V	5 V	5 V			
Rise time *10	50 ms	50 ms	50 ms	50 ms	100 ms	55 ms	75 ms	75 ms	
Fall time	At full load *10	25 ms	25 ms	25 ms	25 ms	80 ms	65 ms	85 ms	85 ms
	Td (typ) *11	285 ms	425 ms	450 ms	570 ms	1370 ms	---		
	No load a *12	65 ms	110 ms	155 ms	175 ms	375 ms	---		
	No load b *13	280 ms	470 ms	470 ms	500 ms	1200 ms	2000 ms	2500 ms	3000 ms
Transient response time *14	1 ms or less					2 ms or less			
Output hold time (typ) *15	15 ms		20 ms			16 ms		14 ms	
<b>Constant current mode</b>									
Maximum line regulation *5 (at the rated output current)	0.01% + 2 mA					0.02%			
Maximum load regulation *16 (at the rated output current)	0.01% + 5 mA					0.09%			
Change in the load due to the temperature drift of internal components (at the rated output current)	0.15% or less (for 30 minutes after the load conditions are changed)					0.05% or less (for 30 minutes after the load conditions are changed)			
Ripple noise *17 (5 Hz to 1 MHz, rms)	150 mA	75 mA	25 mA	8 mA	5 mA	2 mA	1.5 mA	1 mA	
Temperature coefficient	100 PPM /°C (after a 30 minute warm-up, at the rated output current)								
Aging drift *8 (at the rated output current)	0.05%								
Initial drift *9 (at the rated output current)	0.3%	0.15%		0.1%		0.1%			
<b>Protection functions</b>									
Foldback protection	Turns off the output when the operation switches from constant voltage mode to constant current mode or vice versa. Can be set as necessary.								
Overvoltage protection (OVP)	Inverter shutoff system. Prevents the output voltage from being set higher than the OVP value. Also shuts off the output when an output overvoltage (exceeding the OVP value) occurs.								
Overvoltage protection voltage setting range	0.5 V to 12 V	1 V to 24 V	2 V to 40 V	5 V to 66 V	5 V to 110 V	5 V to 176 V	5 V to 353 V	5 V to 717 V	
Undervoltage limit (UVL)	Prevents the output voltage from being set lower than the UVL value. Disabled during external control.								
Undervoltage protection (UVP)	Shuts off the output when the output voltage falls below the UVP value.								
Overheat protection	Shuts off the output before the temperature of the internal components exceeds the safe operation temperature.								

# 600 W Type Specifications

600 W type		PAV 10-60	PAV 20-30	PAV 36-18	PAV 60-10	PAV 100-6	PAV 160-4	PAV 320-2	PAV 650-1	
Setting and readback (USB, RS232, RS485, optional LAN interface)										
Output voltage setting	Accuracy	0.05% of the rated output voltage					0.05% of the output voltage + 0.05% of the rated output voltage			
	Number of decimal digits	3 digits				2 digits				
	Resolution	Approx. 1/60000 of rated output voltage								
Output current setting	Accuracy *18	0.1% of output current + 0.1% of the rated output current					0.2% of the rated output current			
	Number of decimal digits	3 digits				4 digits				
	Resolution	Approx. 1/60000 of rated output current								
Output voltage readback	Accuracy	0.05% of the rated output voltage					0.05% of the output voltage + 0.05% of the rated output voltage			
	Resolution	Approx. 1/60000 of rated output voltage								
Output current readback	Accuracy *18	0.1% of output current + 0.3% of the rated output current								
	Resolution	Approx. 1/60000 of rated output current								
Front panel										
Control function	<ul style="list-style-type: none"> <li>● Separate knobs (encoders) for setting the output voltage and output current (setting resolution switchable).</li> <li>● Knobs (encoders) for setting OVP, UVP, and UVL.</li> <li>● Protection functions (OVP, UVP, UVL, foldback)</li> <li>● Output shutoff function (output on/off control, shutdown)</li> <li>● Communication functions: Standard equipped with USB, RS232, RS485. LAN optional.</li> <li>● Baudrate, address setting</li> <li>● External control: Configuration using external voltage (5 V or 10 V) or external resistance (5 kΩ or 10 kΩ), output voltage/current monitor output (5 V or 10 V), output on/off, front panel operation lock</li> </ul>									
Output voltage display	Accuracy	0.5% of the rated output voltage ± 1 count								
	Number of decimal digits	2 digits				1 digit				
Output current display	Accuracy	0.5% of the rated output current ± 1 count								
	Number of decimal digits	2 digits				3 digits				
LED display	Green: FINE, MENU, SET, ALARM, REM, OUTPUT, CV, CC Red: ALARM (OVP, UVP, OTP, FOLD, AC FAIL)									
Setting keys	FINE, MENU, SET, ALARM, REM, OUTPUT									

- \*1. The minimum voltage is 0.1 % of the rated output voltage.
- \*2. The minimum current is 0.2 % of the rated output current.
- \*3. Input voltage 100 Vac/200 Vac, at the rated output power, ambient temperature 25 °C  
If the LAN option is built in, the efficiency decreases by 0.5 % and the input current increases by 0.5 %.
- \*4. Excludes input surge current (duration 0.2 ms or less) applied to the built-in noise filter section.
- \*5. 85 Vac to 132 Vac or 170 Vac to 265 Vac, fixed load
- \*6. With the input voltage held constant, the sensing point was measured using remote sensing from no load to full load.
- \*7. Models with rated output voltages from 10 V to 100 V were measured using an RC-9131 A 1:1 probe that conforms to the JEITA specifications. Models with rated output voltage from 160 V to 650 V were measured using a 10:1 probe.
- \*8. When at least 8 hours has passed after a 30 minute warm-up with the input voltage, load, and ambient temperature held constant
- \*9. For 30 minutes after turning on the power with the input voltage, load, and ambient temperature held constant
- \*10. Between 10 % and 90 % of the rated resistive load and rated output voltage
- \*11. If the output voltage is repeatedly decreased, Td is the minimum duration from a given voltage drop to the next voltage drop.
- \*12. Duration for the voltage to change from 90 % to 10 % of the rated output voltage when the output voltage is repeatedly decreased and the duration from a given voltage drop to the next voltage drop is longer than Td.

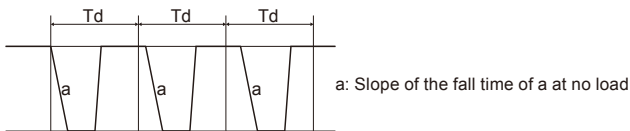

- \*13. Duration for the voltage to change from 90 % to 10 % of the rated output voltage when the output voltage is repeatedly decreased and the duration from a given voltage drop to the next voltage drop is shorter than Td.

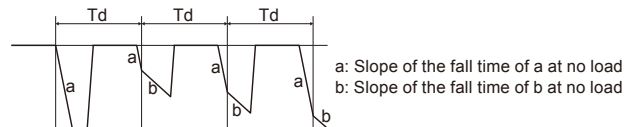

- \*14. The amount of time required for the output voltage to return to a value within 0.5 % of the rated output voltage. The change in the load current is 10 % to 90 % of the rating. The output voltage is between 10 % and 100 % of the rating. During local sensing.
- \*15. At the rated output power
- \*16. The value when the output voltage is changed from the lower limit to the rated voltage in constant current mode with the input voltage held constant
- \*17. For models with a 10 V rated output voltage, this is the value for when the output voltage is 2 V to 10 V at the rated output current. For other models, this is the value for when the output voltage is 10 % to 100 % of the rating at the rated output current. Models with rated output voltage from 160 V to 650 V were measured using a 10:1 probe.
- \*18. In output current control, the current, linearity, and monitor accuracies do not include the load variation caused by initial drift and temperature drift of internal components.

# 800 W Type Specifications

800 W type	PAV 10-72	PAV 20-40	PAV 36-24	PAV 60-14	PAV 100-8	PAV 160-5	PAV 320-2.5	PAV 650-1.25	
<b>Output</b>									
Rated output voltage *1	10 V	20 V	36 V	60 V	100 V	160 V	320 V	650 V	
Rated output current *2	100 Vac ≤ Vin*3 Ta*4 ≤ 50°C	72 A	40 A	24 A	14 A	8 A	5 A	2.5 A	1.25 A
	Vin < 100 Vac Ta ≤ 40°C	72 A	40 A	24 A	14 A	8 A	5 A	2.5 A	1.25 A
	Vin < 100 Vac 40°C < Ta ≤ 50°C	66 A	36 A	20 A	12.5 A	7.5 A	4.7 A	2.35 A	1.15 A
Rated output power	100 Vac ≤ Vin Ta ≤ 50°C	720 W	800 W	864 W	840 W	800 W	800 W	800 W	812.5 W
	Vin < 100 Vac Ta ≤ 40°C	720 W	800 W	864 W	840 W	800 W	800 W	800 W	812.5 W
	Vin < 100 Vac 40°C < Ta ≤ 50°C	660 W	720 W	720 W	750 W	750 W	752 W	752 W	747.5 W
<b>AC input</b>									
Nominal input rating	100 Vac to 240 Vac continuous input, 50 Hz to 60 Hz, single phase								
Input voltage range	85 Vac to 265 Vac								
Input frequency range	47 Hz to 63 Hz								
Input current (typ) *5 (100 Vac/200 Vac)	9.00 A/ 4.45 A	9.65 A/ 4.75 A	10.30 A/ 5.10 A	10.00 A/ 4.95 A	9.50 A/ 4.70 A	9.34 A/ 4.61 A	9.34 A/ 4.59 A	9.43 A/ 4.66 A	
Power factor (typ) (100 Vac/200 Vac, at the rated output power)	0.99 / 0.98								
Efficiency (typ) *5	81% / 83%	84% / 86%	85% / 87%	85% / 87%	85% / 87%	86.5% / 88.5%	86.5% / 89%	87% / 89%	
Inrush current(100 Vac/200 Vac) *6	30 A / 30 A or less								
<b>Constant voltage mode</b>									
Maximum line regulation *7 (for the rated output voltage)	0.01% + 2 mV					0.01%			
Maximum load regulation *8 (for the rated output voltage)									
Ripple noise *9	20 MHz, p-p	50 mV	50 mV	50 mV	60 mV	80 mV	100 mV	150 mV	250 mV
	5 Hz to 1 MHz, rms	5 mV	5 mV	5 mV	12 mV	15 mV	10 mV	30 mV	60 mV
Temperature coefficient	30 PPM /°C (after a 30 minute warm-up, for the rated output voltage)								
Aging drift *10 (for the rated output voltage)	0.05%					0.02%			
Initial drift *11 (for the rated output voltage)	0.05% + 2 mV					0.05%			
Maximum remote sensing compensation voltage (single line (positive or negative))	1 V	1 V	2 V	3 V	5 V	5 V			
Rise time *12	50 ms	50 ms	50 ms	50 ms	100 ms	45 ms	55 ms	55 ms	
Fall time	At full load *12	25 ms	25 ms	25 ms	25 ms	80 ms	55 ms	65 ms	65 ms
	Td (typ) *13	285 ms	425 ms	450 ms	570 ms	1370 ms	---		
	No load a *14	65 ms	110 ms	155 ms	175 ms	375 ms	---		
	No load b *15	280 ms	470 ms	470 ms	500 ms	1200 ms	2000 ms	2500 ms	3000 ms
Transient response time *16	1 ms or less					2 ms or less			
Output hold time (typ) *17	10 ms					13 ms	11.5 ms		
<b>Constant current mode</b>									
Maximum line regulation *7 (at the rated output current)	0.01% + 2 mA					0.02%			
Maximum load regulation *18 (at the rated output current)	0.01% + 5 mA					0.09%			
Change in the load due to the temperature drift of internal components (at the rated output current)	0.15% or less	0.1% or less				0.05% or less			
	(for 30 minutes after the load conditions are changed)								
Ripple noise *19 (5 Hz to 1 MHz, rms)	180 mA	100 mA	31 mA	28 mA	12 mA	2 mA	1.5 mA	1 mA	
Temperature coefficient	100 PPM /°C (after a 30 minute warm-up, at the rated output current)								
Aging drift *10 (at the rated output current)	0.05%								
Initial drift *11 (at the rated output current)	0.3%					0.1%			
<b>Protection functions</b>									
Foldback protection	Turns off the output when the operation switches from constant voltage mode to constant current mode or vice versa. Can be set as necessary.								
Overvoltage protection (OVP)	Inverter shutoff system. Prevents the output voltage from being set higher than the OVP value. Also shuts off the output when an output overvoltage (exceeding the OVP value) occurs.								
Overvoltage protection voltage setting range	0.5 V to 12 V	1 V to 24 V	2 V to 40 V	5 V to 66 V	5 V to 110 V	5 V to 176 V	5 V to 353 V	5 V to 717 V	
Undervoltage limit (UVL)	Prevents the output voltage from being set lower than the UVL value. Disabled during external control.								
Undervoltage protection (UVP)	Shuts off the output when the output voltage falls below the UVP value.								
Overheat protection	Shuts off the output before the temperature of the internal components exceeds the safe operation temperature.								

# 800 W Type Specifications

800 W type	PAV 10-72	PAV 20-40	PAV 36-24	PAV 60-14	PAV 100-8	PAV 160-5	PAV 320-2.5	PAV 650-1.25
Setting and readback (USB, RS232, RS485, optional LAN interface)								
Output voltage setting	Accuracy	0.05% of the rated output voltage				0.05% of the output voltage + 0.05% of the rated output voltage		
	Number of decimal digits	3 digits			2 digits			
	Resolution	Approx. 1/60000 of rated output voltage						
Output current setting	Accuracy *20	0.1% of output current + 0.1% of the rated output current				0.2% of the rated output current		
	Number of decimal digits	2 digits	3 digits			4 digits		
	Resolution	Approx. 1/60000 of rated output current						
Output voltage readback	Accuracy	0.05% of the rated output voltage				0.05% of the output voltage + 0.05% of the rated output voltage		
	Resolution	Approx. 1/60000 of rated output voltage						
Output current readback	Accuracy *20	0.1% of output current + 0.3% of the rated output current						
	Resolution	Approx. 1/60000 of rated output current						
Front panel								
Control function	<ul style="list-style-type: none"> <li>● Separate knobs (encoders) for setting the output voltage and output current (setting resolution switchable).</li> <li>● Knobs (encoders) for setting OVP, UVP, and UVL.</li> <li>● Protection functions (OVP, UVP, UVL, foldback)</li> <li>● Output shutoff function (output on/off control, shutdown)</li> <li>● Communication functions: Standard equipped with USB, RS232, RS485. LAN optional.</li> <li>● Baudrate, address setting</li> <li>● External control: Configuration using external voltage (5 V or 10 V) or external resistance (5 kΩ or 10 kΩ), output voltage/current monitor output (5 V or 10 V), output on/off, front panel operation lock</li> </ul>							
Output voltage display	Accuracy	0.5% of the rated output voltage ± 1 count						
	Number of decimal digits	2 digits			1 digit			
Output current display	Accuracy	0.5% of the rated output current ± 1 count						
	Number of decimal digits	2 digits			3 digits			
LED display	Green: FINE, MENU, SET, ALARM, REM, OUTPUT, CV, CC Red: ALARM (OVP, UVP, OTP, FOLD, AC FAIL)							
Setting keys	FINE, MENU, SET, ALARM, REM, OUTPUT							

- \*1. The minimum voltage is 0.1% the rated output voltage.
- \*2. The minimum current is 0.2% of the rated output current.
- \*3. Vin: Input voltage
- \*4. Ta: Ambient temperature (performance depending on the input voltage versus rated output current and ambient temperature shown below)

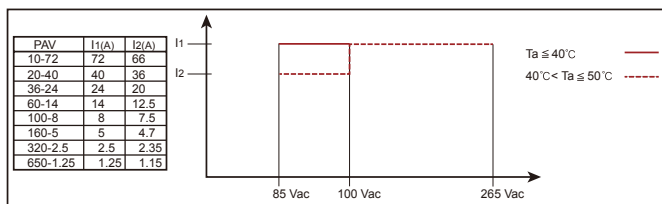

- \*5. Input voltage 100 Vac/200 Vac, at the rated output power, ambient temperature 25 °C  
If the LAN option is built in, the efficiency decreases by 0.5% and the input current increases by 0.5%.
- \*6. Excludes input surge current (duration 0.2 ms or less) applied to the built-in noise filter section.
- \*7. 85 Vac to 132 Vac or 170 Vac to 265 Vac, fixed load
- \*8. With the input voltage held constant, the sensing point was measured using remote sensing from no load to full load.
- \*9. Models with rated output voltages from 10 V to 100 V were measured using an RC-9131 A 1:1 probe that conforms to the JEITA specifications. Models with rated output voltage from 160 V to 650 V were measured using a 10:1 probe. At an ambient temperature of 0 °C, measurement was performed after at least 1 minute had passed after startup.
- \*10. When at least 8 hours has passed after a 30 minute warm-up with the input voltage, load, and ambient temperature held constant
- \*11. For 30 minutes after turning on the power with the input voltage, load, and ambient temperature held constant
- \*12. Between 10% and 90% of the rated resistive load and rated output voltage
- \*13. If the output voltage is repeatedly decreased, Td is the minimum duration from a given voltage drop to the next voltage drop.

- \*14. Duration for the voltage to change from 90% to 10% of the rated output voltage when the output voltage is repeatedly decreased and the duration from a given voltage drop to the next voltage drop is longer than Td.

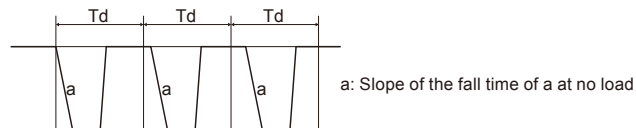

- \*15. Duration for the voltage to change from 90% to 10% of the rated output voltage when the output voltage is repeatedly decreased and the duration from a given voltage drop to the next voltage drop is shorter than Td.

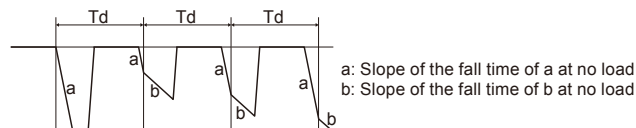

- \*16. The amount of time required for the output voltage to return to a value within 0.5% of the rated output voltage. The change in the load current is 10% to 90% of the rating. The output voltage is between 10% and 100% of the rating. During local sensing.
- \*17. At the rated output power
- \*18. The value when the output voltage is changed from the lower limit to the rated voltage in constant current mode with the input voltage held constant
- \*19. For models with a 10 V rated output voltage, this is the value for when the output voltage is 10 % to 100 % of the rating at the rated output current. Models with rated output voltage from 160 V to 650 V were measured using a 10:1 probe.
- \*20. In output current control, the current, linearity, and monitor accuracies do not include the load variation caused by initial drift and temperature drift of internal components.

# Specifications common to all types

External control	
Output voltage control using external voltage	0% to 100% of the rated output voltage (application voltage range selectable: 0 V to 5 V or 0 V to 10 V) Accuracy and linearity: $\pm 0.5\%$ of the rated output voltage
Output current control using external voltage *1	0% to 100% of the rated output current (application voltage range selectable: 0 V to 5 V or 0 V to 10 V) Accuracy and linearity: $\pm 1\%$ of the rated output current
Output voltage control using external resistance	0% to 100% of the rated output voltage (application resistance range selectable: 0 $\Omega$ to 5 k $\Omega$ or 0 $\Omega$ to 10 k $\Omega$ ) Accuracy and linearity: $\pm 1\%$ of the rated output voltage
Output current control using external resistance *1	0% to 100% of the rated output current (application resistance range selectable: 0 $\Omega$ to 5 k $\Omega$ or 0 $\Omega$ to 10 k $\Omega$ ) Accuracy and linearity: $\pm 1.5\%$ of the rated output current
Output shutoff (SO) control	External voltage application: 0 V to 0.6 V, 4 V to 15 V, or a contact switch. Positive or negative logic selectable.
Output current monitor *1	Monitor voltage range selectable: 0 V to 5 V or 0 V to 10 V, Accuracy: 1%
Output voltage monitor	Monitor voltage range selectable: 0 V to 5 V or 0 V to 10 V, Accuracy: 1%
Normal operation status signal	Normal (4 V to 5 V), abnormal (0 V), output resistance 500 $\Omega$
Parallel operation *2 *3	Possible up to six power supplies. Master-slave operation with a current balance function.
Series operation *4	Possible up to two power supplies.
Constant voltage/constant current mode (CV/CC) signal	Open collector output (maximum application voltage 30 V, maximum sink current 10 mA) Low level (on) during constant current (CC) mode High level (off) during constant voltage (CV) mode
Output on / off control (ILC)	Output can be shut off using a contact switch or the like (maximum voltage between terminals: 5 V). When open: Output off When shorted: Output on
Local / remote	Can be switched by applying an external voltage or by opening or shorting the circuit. Local: 2 V to 15 V or open Remote: 0 V to 0.6 V or shorted
External control status signal	Open collector output (maximum application voltage 30 V, maximum sink current 10 mA) High level (off) during local mode Low level (on) during external control
Trigger output signal	Maximum low level output signal: 0.8 V Minimum high level output signal: 3.8 V, maximum high level output signal: 5 V Maximum source current: 16 mA, output trigger signal span: 20 $\mu$ s (typ)
Trigger input signal	Maximum low level input signal: 1.2 V Minimum high level input signal: 3.5 V, maximum high level input signal: 5 V Maximum sink current: 16 mA, positive edge trigger span: 10 $\mu$ s (min), Tr/Tf: 1 $\mu$ s (max)
Program signal output 1	Open collector output (maximum application voltage 25 V, maximum sink current 100 mA)
Program signal output 2	
Environmental conditions	
Operating ambient temperature and humidity	0 °C to 50 °C (32 °F to 122 °F) 20%rh to 90%rh (no condensation)
Storage ambient temperature and humidity	-20 °C to 85 °C (-4 °F to 185 °F) 10%rh to 95%rh (no condensation)
Installation location	Indoor use, Overvoltage category II Altitude: Up to 3000 m (at 2000 m and above, the operating ambient temperature must be reduced), At 2000 m to 3000 m, the operating ambient temperature is 0 °C to 40 °C (32 °F to 104 °F).
Structure	
Cooling method	Forced air cooling using internal fan
Weight	1.9 kg (4.2 lb) or less: 200 W, 400 W types (models whose rated output voltage is 10 V to 100 V and 160 V to 650 V) 2.0 kg (4.4 lb) or less: 600 W, 800 W types (models whose rated output voltage is 160 V to 650 V) 2.1 kg (4.6 lb) or less: 600 W, 800 W types (models whose rated output voltage is 10 V to 100 V)
Dimensions	See the outline drawing.
Vibration resistance	IEC60068-2-64
Shock resistance	196.1 m/s <sup>2</sup> (20 G) or less, half sine, 11 ms, when not packaged, when not operating (IEC 60068-2-27)
*1. In output current control, the current, linearity, and monitor accuracies do not include the load variation caused by initial drift and temperature drift of internal components.	
*2. For parallel operation of two or more PAV series power supplies with the same rating, the minimum load current is 5% of the rating or higher. For parallel operation of four or less models with rated output voltage of 160 V to 650 V, the minimum load current is 5% of the rating or higher. For parallel operation of more than four, the minimum load current is 20% of the rating or higher.	
*3. The ammeter's display accuracy when the total current is displayed on the master unit is 2% $\pm$ 1 count of the total of rated currents.	
*4. An external protection diode is necessary.	
Safety / EMC	
Safety standards	Complies with the requirements of the following directive and standards. Low Voltage Directive 2014/35/EU UL/EN/IEC 61010-1 (Class I *1, Pollution degree 2 *2) (Design to meet UL/EN 60950-1) ●Models whose rated output voltage is 10 V, 20 V, 36 V, or 60 V Output terminals and signal terminals produce non-hazardous voltage. ●Models whose rated output voltage is 100 V, 160 V, 320 V, or 650 V Output terminals and J1 and J2 terminals produce hazardous voltage (other signal terminals produce non-hazardous voltage).
EMC standards	Complies with the requirements of the following directive and standards. EMC Directive 2014/30/EU EN/IEC 61326-1 (Design to meet EN 55022/EN 55024)
Withstanding voltage *3	●Models whose rated output voltage is 10 V, 20 V, or 36 V 4242 Vdc: Between input and output (including between signal terminals) 2828 Vdc: Between input and FG 707 Vdc: Between output (including between signal terminals) and FG ●Models whose rated output voltage is 60 V or 100 V 4242 Vdc: Between input and output (including between signal terminals) 2828 Vdc: Between input and FG 707 Vdc: Between signal terminals (excluding J1/J2) and FG 1910 Vdc: Between output as well as J1/J2 terminals and signal terminals (excluding J1/J2) 1380 Vdc: Between output as well as J1/J2 terminals and FG

Withstanding voltage *3	<ul style="list-style-type: none"> <li>Models whose rated output voltage is 160 V or 320 V           <ul style="list-style-type: none"> <li>2970 Vdc: Between input and output (including between signal terminals)</li> <li>2828 Vdc: Between input and FG               <ul style="list-style-type: none"> <li>707 Vdc: Between signal terminals (excluding J1/J2) and FG</li> </ul> </li> <li>4242 Vdc: Between input and signal terminals (excluding J1/J2)</li> <li>3200 Vdc: Between output as well as J1/J2 terminals and signal terminals (excluding J1/J2)</li> <li>2000 Vdc: Between output as well as J1/J2 terminals and FG</li> </ul> </li> <li>Models whose rated output voltage is 650 V           <ul style="list-style-type: none"> <li>3704 Vdc: Between input and output (including between signal terminals)</li> <li>2828 Vdc: Between input and FG               <ul style="list-style-type: none"> <li>707 Vdc: Between signal terminals (excluding J1/J2) and FG</li> </ul> </li> <li>4242 Vdc: Between input and signal terminals (excluding J1/J2)</li> <li>4244 Vdc: Between output as well as J1/J2 terminals and signal terminals (excluding J1/J2)</li> <li>2780 Vdc: Between output as well as J1/J2 terminals and FG</li> </ul> </li> </ul>
Insulation resistance	100 MΩ or higher (25 °C, 70%rh)
Conducted emission	IEC/EN 61326-1, Class B, FCC part15-B, VCCI-B
Radiated emission	IEC/EN 61326-1, Class A *4, FCC part15-A, VCCI-A

\*1. This is a Class I equipment. Be sure to ground the product's protective conductor terminal. The safety of this product is only guaranteed when the product is properly grounded.

\*2. Pollution is addition of foreign matter (solid, liquid or gaseous) that may produce a reduction of dielectric strength or surface resistivity.

Pollution Degree 2 assumes that only non-conductive pollution will occur except for an occasional temporary conductivity caused by condensation.

\*3. Test voltage application time: 1 minute

\*4. This is a Class A equipment. The product is intended for use in an industrial environment. This product may cause interference if used in residential areas. Such use must be avoided unless the user takes special measures to reduce electromagnetic emissions to prevent interference to the reception of radio and television broadcasts.

## Accessories

### Models whose rated output voltage is 10 V to 100 V

Name	Model	Quantity
Bus bar screw set	Flat washer M6	4
	Spring washer M6	2
	Hex nut M6	2
	Pan head screw M6×16	2
Bus bar cover (top and bottom)		1 each
PT screws KA40×8 WN1412		2
J1, J2, and J3 connector cover		1
Connector housing 12P (IPD1-06-D-K by SAMTEC)		1
Connector housing 8P (IPD1-04-D-K by SAMTEC)		1
Connector housing 4P (IPD1-02-D-K by SAMTEC)		1
Contact pins (CC79L-2024-01-L by SAMTEC)		26

### Models whose rated output voltage is 160 V to 650 V

Name	Quantity
Output terminal plug 4P (IC2.5/4-ST-5.08 by PHOENIX CONTACT)	1
Output terminal cover (top and bottom)	1 each
PT screws KA30×6 WN1312	1
Connector housing 12P (43024-1208 by MOLEX)	1
Connector housing 8P (43645-0800 by MOLEX)	1
Connector housing 5P (43645-0500 by MOLEX)	1
Contact pins (43030-0002 by MOLEX)	26

### Common to all models

Name	Quantity
Setup Guide	1 copy
Quick Reference	1 English copy, 1 Japanese copy
Safety Information	1 copy
Power code	1
RS485 link cable	1
CD-ROM	1 pc.

## Options

Name	Model	Remarks
Power cord*	PAV/J (PSE)	For Japan. 15 Aac, 125 Vac, 2 m (JIS C 8303 type)
	PAV/U (UL)	For United States. 13 Aac, 125 Vac, 2 m (NEMA-5-15P type)
	PAV/E (EN)	For Europe. 10 Aac, 250 Vac, 2 m (IEC60884-1 type)
	PAV/O	10 Aac, 250 Vac, 2 m (plugless type)
Housing cover rack mount	KRA2-PAV	EIA /JIS rack mount adapter
	CC01-PAV	Half-size housing cover
	KBP2-6-PAV	1/6 width blank panel
RS232 and RS485 cables	PAG/485-9	RS485 cable with Dsub 9-pin and RJ-45 connectors. Length: Approx. 2 m
	PAG/232-9	RS232 cable with Dsub 9-pin and RJ-45 connectors. Length: Approx. 2 m
	PAG/232-25	RS232 cable with Dsub 25-pin and RJ-45 connectors. Length: Approx. 2 m
RS485 link cable	PAG/RJ45	Serial link cable with shielded RJ-45 connectors. Length: Approx. 0.5 m

\* The main body includes a PAV-J.

# Outline drawing

## ●Type I : Models whose rated output voltage is 10 V to 100 V

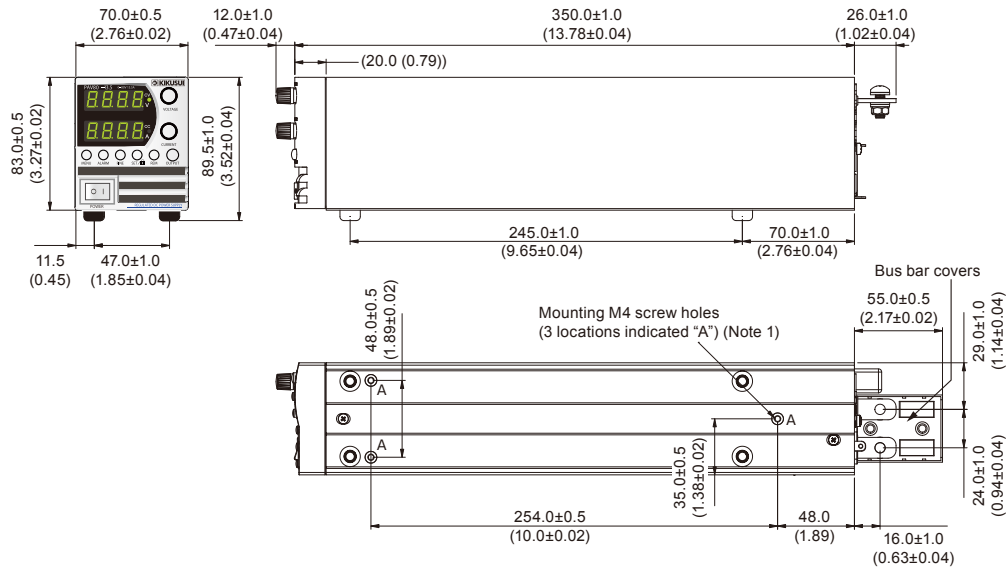

(Note 1) Keep screw insertion depth to 6 mm or less.

Unit: mm (inches)

## ●Type II : Models whose rated output voltage is 160 V to 650 V

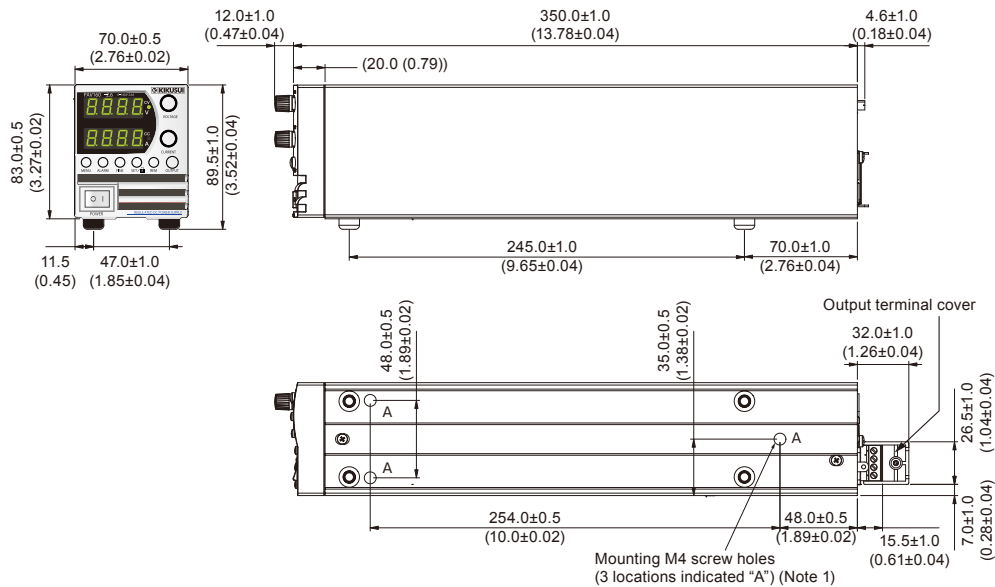

(Note 1) Keep screw insertion depth to 6 mm or less.

Unit: mm (inches)



### KIKUSUI ELECTRONICS CORPORATION

1-1-3, Higashiyamata, Tsuzuki-ku, Yokohama, Kanagawa, 224-0023, Japan  
 Phone: (+81)45-593-0200, Facsimile: (+81)45-593-7591, <https://global.kikusui.co.jp/>

KIKUSUI AMERICA, INC. 1-310-214-0000 [www.kikusuiamerica.com](http://www.kikusuiamerica.com)



3625 Del Amo Blvd, Suite 160, Torrance, CA 90503  
 Phone : 310-214-0000 Facsimile : 310-214-0014

KIKUSUI TRADING (SHANGHAI) Co., Ltd. [www.kikusui.cn](http://www.kikusui.cn)



Room 305, Shenggao Building, No.137, Xianxia Road, Shanghai City, China  
 Phone : 021-5887-9067 Facsimile : 021-5887-9069

For our local sales distributors and representatives, please refer to "sales network" of our website.

Printed in Japan

## ●Distributor/Representative

■ All products contained in this catalogue are equipment and devices that are premised on use under the supervision of qualified personnel, and are not designed or produced for home-use or use by general consumers. ■ Specifications, design and so forth are subject to change without prior notice to improve the quality. ■ Product names and prices are subject to change and production may be discontinued when necessary. ■ Product names, company names and brand names contained in this catalogue represent the respective registered trade name or trade mark. ■ Colors, textures and so forth of photographs shown in this catalogue may differ from actual products due to a limited fidelity in printing. ■ Although every effort has been made to provide the information as accurate as possible for this catalogue, certain details have unavoidably been omitted due to limitations in space. ■ If you find any misprints or errors in this catalogue, it would be appreciated if you would inform us. ■ Please contact our distributors to confirm specifications, price, accessories or anything that may be unclear when placing an order or concluding a purchasing agreement.

Issue: Nov.2022 202211PDFEC21